

**Sanitarios y Suites de Baño**

# Serie Vision



La gama Vision incluye todo el set de productos para el baño.

La alta velocidad de rotación de la bomba de vórtice y el diseño geométrico de la tubería de todos los equipos Planus permiten crear un gran vacío capaz de eliminar el agua y los residuos orgánicos de la taza. El alto nivel de rendimiento garantizan la máxima flexibilidad en la planificación de la ruta de las mangueras de descarga, que le permite alcanzar distancias y alturas importantes.

Serie Vision	
Referencia	Descripción
PLVISION-12V	WC VISION 12V
PLVISION-24V	WC VISION 24V
PLVISION-230V	WC VISION 230V
PLVISION-12V/WJ	WC VISION 12V WATER JET
PLVISION-24V/WJ	WC VISION 24V WATER JET
PLVISION-230V/WJ	WC VISION 230V WATER JET
PLVISION BIDET	BIDET VISION

**TECHNICAL SPECIFICATION OF THE MAIN COMPONENTS**

**Vortex Discharge Pump**

Hydraulic performances: up to 9 m vertically, up to 80 m horizontally

Voltage	12 Vdc	24 Vdc	230 Vac
Absorption	35 A	25 A	3 A

**Inlet Electrovalve**

**DIRECT ACTING** Version (for both fresh water and sea water inlet systems)

Voltage	12 Vdc	24 Vdc	230 Vac
Absorption	80 W	80 W	80 W

**SERVO PILOTED** Version (for fresh water inlet only)

Voltage	12 Vdc	24 Vdc	230 Vac
Absorption	15 W	15 W	15 W

**Independent Inlet Pump**

Voltage	12 Vdc	24 Vdc	230 Vac
Absorption	3.6 A	1.8 A	

**Centralized Inlet Pump (not supplied)**

Recommended specifications Working Pressure Min 1 bar—Max 3 bar



Discharge pressure 0.9 bar (9m)



Up to 80 m

1	CERAMIC BOWL		
2	COMPLETE FIXING BRACKET		PW.026.00
3	VORTEX OUTLET PUMP	12v	PW.001.00
		24v	PW.002.00
		230v	PW.034.00
3a	Motor	12v	04.001.00
		24v	04.002.00
		230v	04.025.00
3b	Flange for pump		02.005.00
3c	Sealing for pump		03.006.00
3d	Stationary seal for impeller		05.001.00
3e	Rotatory seal for impeller		05.002.00
3f	Impeller		02.004.00
3g	Housing for pump		02.003.00
3h	One-way valve		03.005.00
3i	Clamp for one-way value		02.009.00
4	SIPHON HOSE		PW.003.00
5	DISCHARGE HOSE COMPLETE		PW.005.00
5a	Discharge hose		03.002.00
5b	One-way valve - Assembly		PW.006.00
6	INLET PIPE		PW.007.00
7	SEAT & COVER		

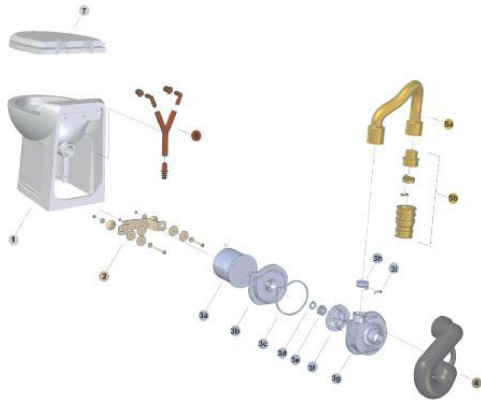

**Toilet and Bidet**

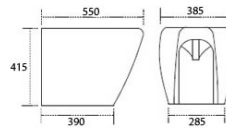
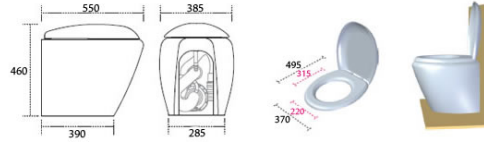

**Wash basin 47/70/90**

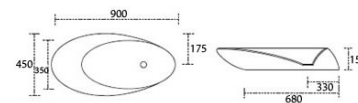
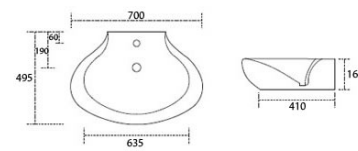
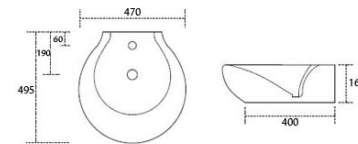

**CONNECTIONS**

**Hydraulic Connections**

Inlet	Hose with ID of 20 mm (3/4")
Outlet	Hose with ID of 40 mm (1/2")

**Electrical Connections**

Voltage	12 Vdc	24 Vdc	230 Vac
Minimal wire gauge up to 5 m	6 mm <sup>2</sup> (9 AWG)	4 mm <sup>2</sup> (11 AWG)	0.75 mm <sup>2</sup> (18 AWG)
Minimal wire gauge over 5 m	10 mm <sup>2</sup> (7 AWG)	6 mm <sup>2</sup> (9 AWG)	1 mm <sup>2</sup> (17 AWG)

**Bath tub**

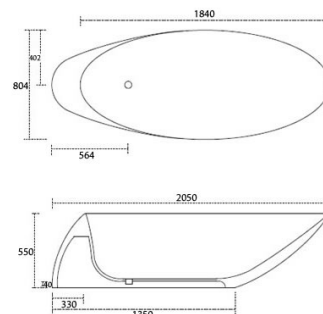

**INFO**

**Weight:** 26kg (High Version) - 23.5 kg (Short Version)  
**Average Water Consumption:** 1.5 l  
**Color:** White (black or bone optional)  
**Seat:** Wood covered with casting resin  
**Hinges:** Stainless steel (soft closing system optional)  
**Integrated bidet:** Optional