

WINDOWSHADE 2 SOLARSHIELD

Installation Instructions

Cord Control – Free Hanging

Pack contains

- 1 x Headrail and blind
- 2 or 3 x Headrail mounting brackets depending on width of blind.
- 1 x Cord hold down
- 1 x Cord jammer
- 1 x Cord pulley
- 1 x Toggle

Installation Method

1. Check headrail and blind is the correct size for the recess.
2. Fit the mounting brackets to recess. Brackets to be positioned 100mm from each end of the headrail, and if the headrail is over 700mm wide then one bracket should be fitted centrally. Ensure the brackets are in line if 3 are fitted. Use a 5mm diameter pan head fixing of the appropriate length and type for the substrate being fixed to. Leave a minimum of 20mm between the back of the bracket and the window. (fig1)
3. Clip the headrail in place into the mounting brackets, so that the blind is central to the window, and check the headrail is secure. (fig 2 to fig 5)

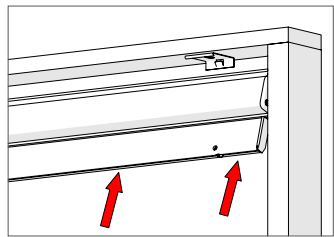
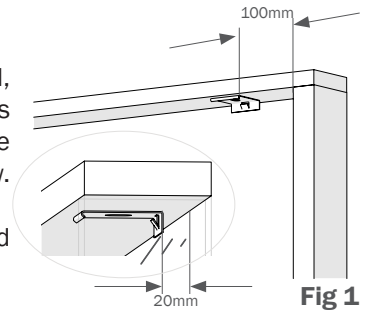

Fig 2

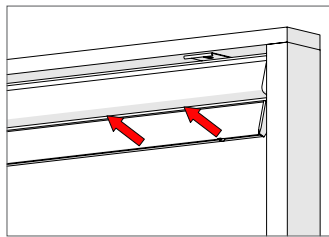

Fig 3

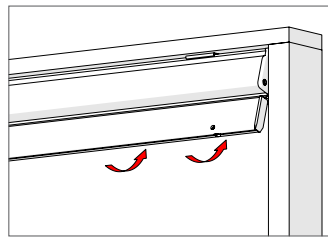

Fig 4

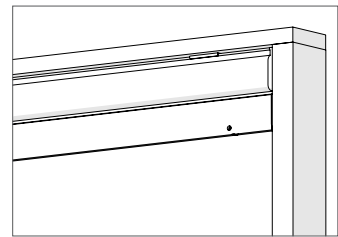

Fig 5



4. Fix the base fixing for the Cord hold down 76mm from the edge of the recess, using 3.2mm diameter countersunk head fixing of the appropriate length and type for the substrate being fixed to. Screw on the hold down dome with cord attached, onto the base fixing. (fig 6 & fig 7)

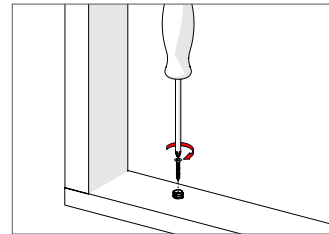

Fig 6

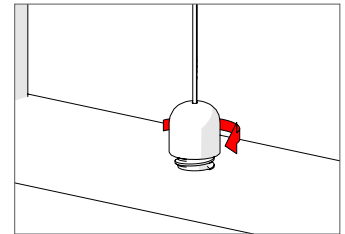

Fig 7

5. Fix the pulley in place using 4.2mm diameter pan head fixings (4 off), 64mm from the recess. (fig 8)

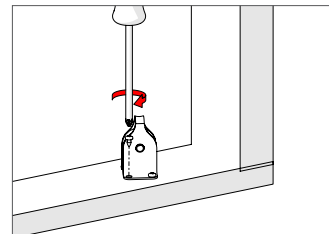

Fig 8

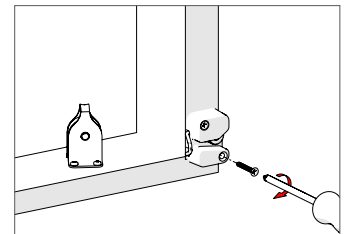

fig 9

6. Fix the jammer in a suitable position using two 3.5mm diameter countersunk head fixings of the appropriate length and type for the substrate being fixed to. (fig 9)

7. Thread the pull cord through the pulley and jammer and then slide on the toggle onto the cord. Tie off the cord so the toggle is in the required position for the user operation. When the blind has been checked for correct operation then cut off any spare cord. (fig 10)

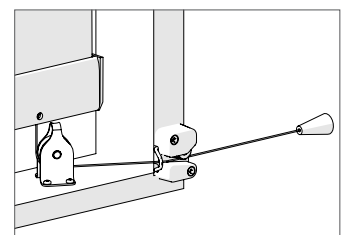

fig 10

8. Check the operation of the blind.

Note:

This blind is not suitable to be located where children under the age of 42 months are allowed.

WINDOWSHADE 2 SOLARSHIELD

Installation Instructions

Cord Control – Guide Wire

Pack contains

- 1 x Headrail and blind
- 2 or 3 x Headrail mounting brackets depending on width of blind.
- 1 x Cord hold down
- 1 x cord jammer
- 1 x Cord pulley
- 1 x Toggle
- 2 x Guide wire hold down
- 2 x Barrel Bolt for Guide wire hold down

Installation Method

Follow steps 1 to 7 on page 1 and then carry out the following steps for the fitting of the guide wires.

1. Fix one of the base fixings for the Guide wire hold down, so the guide wire is parallel to the edge of the recess, using 3.2mm diameter countersunk head fixing of the appropriate length and type for the substrate being fixed to (fig 11).

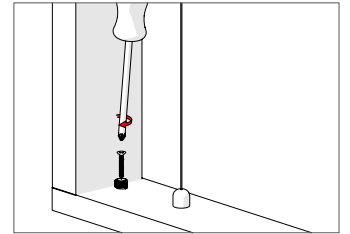

fig 11

2. Slide the hold down dome onto the guide wire and then the barrel clamp, and pulling the guide wire taut fix the barrel bolt so that the lower face is 1mm above the installation base. Screw on the hold down dome and check that the guide wire is taut. Repeat for the second guide wire hold down, ensuring the 2 guide wires are parallel.

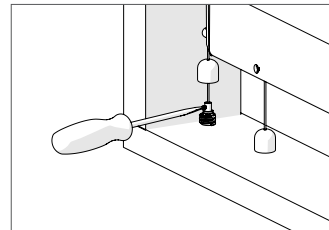

fig 13

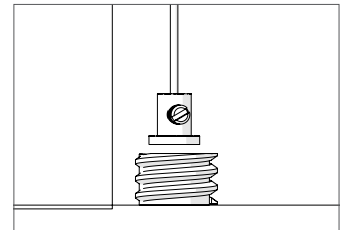

fig 12

3. Check the operation of the blind .