

VIEW FROM INBOARD

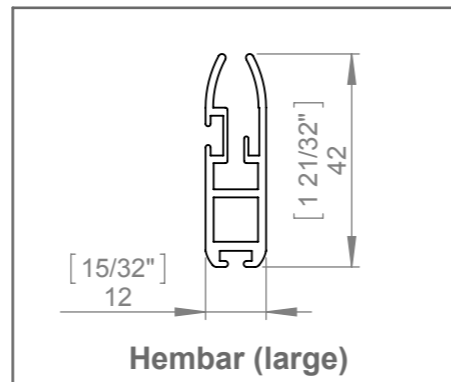
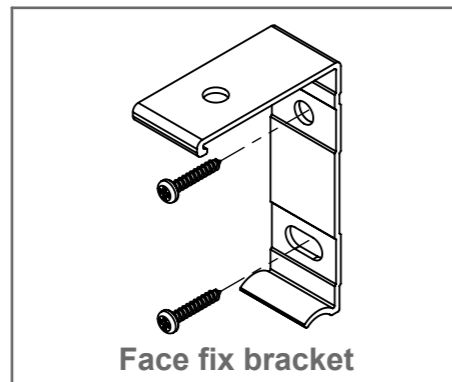
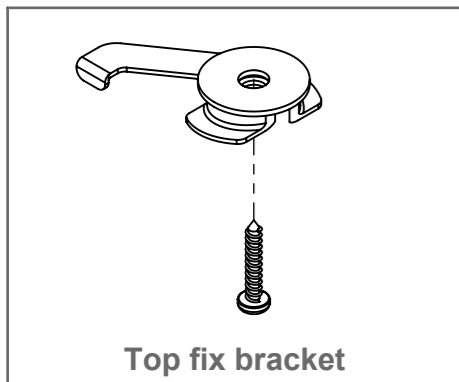

X(Width) & Y(Drop) Limits		
X(Min)	X(Max)	Y
550 [21 21/32"]	2400 [94 1/2"]	See Note 2

- Notes:
- 1 Overall head rail size (X) = Recess - 4 [5/32"].
  - 2 Maximum drop (Y) fabric dependant, consult Oceanair.
  - 3 Hembar (small) shown, hembar (large) available depending on blind size and fabric, consult Oceanair.
  - 4 Bracket quantity dependent on width of blind.
  - 5 Allow sufficient space for installation.
  - 6 Dimensions in millimeters (Imperial equivalents are shown for reference only).