

VIEW FROM INBOARD

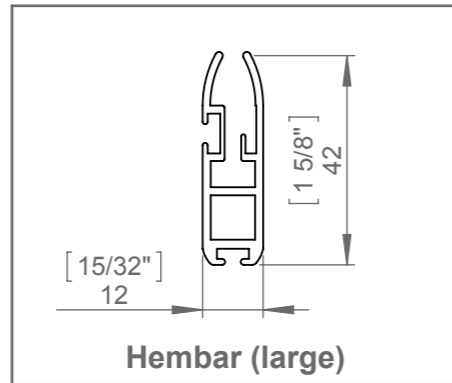
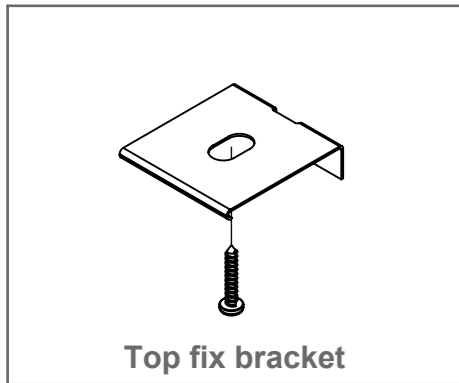

X(Width) & Y(Drop) Limits		
X (Min)	X (Max)	Y
360 [14 3/16"]	1900 [74 13/16"]	See Note 2

- Notes:
- 1 Overall head rail size (X) = Recess - 4 [5/32"].
 - 2 Maximum drop (Y) fabric dependant, consult Oceanair.
 - 3 Hembar (small) shown, hembar (large) available depending on blind size and fabric, consult Oceanair.
 - 4 Bracket quantity dependent on width of blind.
 - 5 Allow sufficient space for installation.
 - 6 Dimensions in millimeters (Imperial equivalents are shown for reference only).